

MPI TS2000-IFE Series | 200 mm Automated Probe Systems

The Dedicated System for mmW, Load-pull, SiPH and Product Engineering

FEATURES / BENEFITS

Designed for Variety of On-Wafer Applications

- DC-IV / DC-CV / Pulsed-IV applications
- Silicon photonics
- RF, mmW, load-pull applications & 4-port setup
- IC Design Validation, Failure Analysis in wide temperature range from -60 to 300 °C
- Wafer Level Reliability

Extended Flexibility

- MPI IceFreeEnvironment™ for using MicroPositioners and probe cards simultaneously, even at negative temperature
- Programmable microscope movements for more automation and ease of use
- The shortest cable interface to IC tester
- Minimize the platen-to-chuck distance for mmW & probing with active probes
- Supports film-frame probing

Ergonomic Design and Footprint

- Easy wafer or single DUT loading from the front
- Integrated active vibration isolation
- Completely integrated prober control for faster, safer and convenient system and test operation
- The Safety Test Management (STM™) with automated dew point control
- Reduced footprint due to smart chiller space arrangement
- Instrument shelf option for shorter cables and higher measurement dynamic



STAGE SPECIFICATIONS

Chuck XY Stage (Programmable)

Travel range	220 x 490 mm (8.66 x 19.29 in)
Resolution	0.2 μm
Accuracy	< 2.0 μm (0.08 mils)
Repeatability	< 1 μm
XY stage drive	Closed-loop high precision stepper motors
Speed*	Slowest: 10 μm / sec Fastest: 50 mm / sec

Chuck Z Stage (Programmable)

Travel range	30 mm (1.18 in)
Resolution	0.2 μm
Accuracy	< 2.0 μm
Repeatability	< 1.0 μm
Z stage drive	Closed-loop high precision stepper motor
Speed*	Slowest: 10 μm / sec Fastest: 20 mm / sec
Guider	Precision ball bearings

*The speed is instantaneous speed, not average speed. There is accelerate and decelerate time when moving.

STAGE SPECIFICATIONS

Chuck Theta Stage (Programmable)

Travel range	± 5.0°
Resolution	0.0001°
Accuracy	< 2.0 µm (measured at the edge of the 200 mm chuck)
Repeatability	< 1.0 µm
Theta stage drive	High resolution stepper motor with linear encoder feedback system

MICROSCOPE MOVEMENT

	XYZ Programmable	XY manual, Z programmable	XYZ manual
XY - Travel range	50 x 50 mm* / 100 x 50 mm / 200 x 200 mm	50 x 50 mm / 80 x 80 mm	50 x 50 mm / 100 x 100 mm
Resolution	1 µm (0.04 mils)	< 5 µm (0.2 mils)	< 5 µm (0.2 mils)
Repeatability	< 2 µm (0.08 mils)	N/A	N/A
Accuracy	< 5 µm (0.2 mils)	N/A	N/A
Z - Travel range	140 mm	140 mm	140 mm, pneumatic
Resolution	0.05 µm (0.002 mils)	0.05 µm (0.002 mils)	N/A
Repeatability	< 2 µm (0.08 mils)	< 2 µm (0.08 mils)	< 2 µm (0.08 mils)
Accuracy	< 4 µm (0.16 mils)	< 4 µm (0.16 mils)	N/A

*Heavy duty version for laser cutter option available

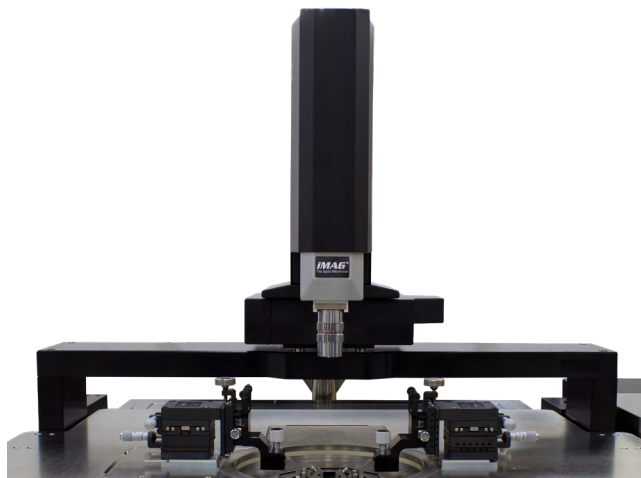

XYZ programmable movement

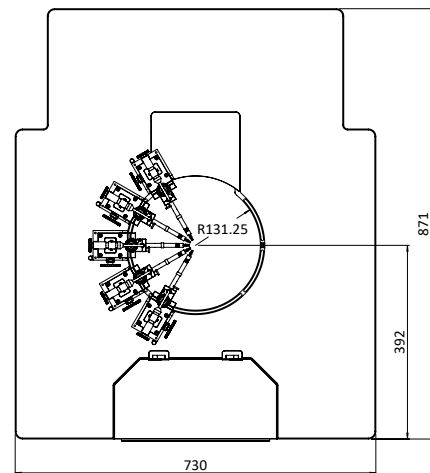

Large Probe Platen supporting up to 10x DC or 4x DC + 4x RF MicroPositioners or standard 4.5" probe card holder

PROBE PLATEN

Specifications

Material	Nickel plated steel
Chuck top to platen top	Min. 28 mm
Platen cooling	Fully integrated CDA cooling, by using the chiller CDA
Configuration	Probe card holder 4.5 x 11" and/or MicroPositioners
Max. No. of MicroPositioners	10x DC MicroPositioners or 4x DC + 4x RF MicroPositioner Setup
RF MicroPositioner mounting	Magnetic with guided rail
DC MicroPositioner mounting	Magnetic

KEY FEATURES

IceFreeEnvironment™

MPI IceFreeEnvironment™ provides unique capability to perform measurements with probe cards and MicroPositioners simultaneously, especially at negative temperatures down to -60 °C.

Internal node probing with active/passive high impedance probes is very convenient.

The optimized design with minimal tip drop for highest dynamic range and gamma of mmWave and Load Pull measurements make the system an ideal choice for RF/mmW applications on 200 mm wafers.

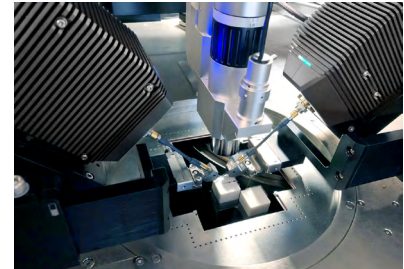

Manual Wafer Loading

Loading or unloading of wafer up to 200 mm or substrates is straight forward and intuitive. Special designed chucks allowing easy single ICs or wafer fragments loading in the front. Furthermore MPI SmartVacuum™ technology allows automated wafer size or single Die recognition and protects the wafer in case of power interruptions or inexperience operators from releasing the vacuum inside the IceFreeEnvironment™.

No roll-out stage allows for a simple method of automation for RF calibration and probe card cleaning. Easy access to the AUX chucks for handling of calibration substrates, cleaning or contact check pads.

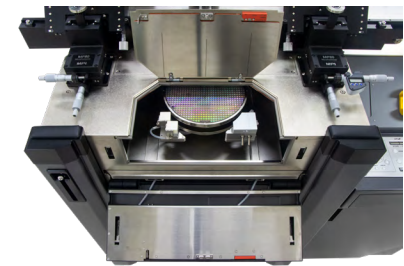
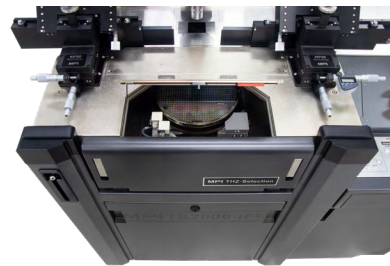

Integrated Controls

The thermal chuck can be operated by using the fully integrated touchscreen display, placed at convenient location in front of the operator for fast operation and immediate feedback.

The intelligent hardware control panel is completely integrated into the probe system and is designed to provide faster, safer and convenient system control and test operation.

The Keyboard and mouse are strategically located to control the software and it can also control the Windows® based instrumentation.

USB connection to the systems controller is located right in front for convenient data exchange.



Probe Hover Control™

MPI Probe Hover Control PHC™ allows easy manual control of probe contact and separation to wafer. Separation distance can accurately control with micrometer feedback for probe to wafer/pad positioning. Ease of use guarantees the safest operation by minimizing error during critical set-up and probe change operations.

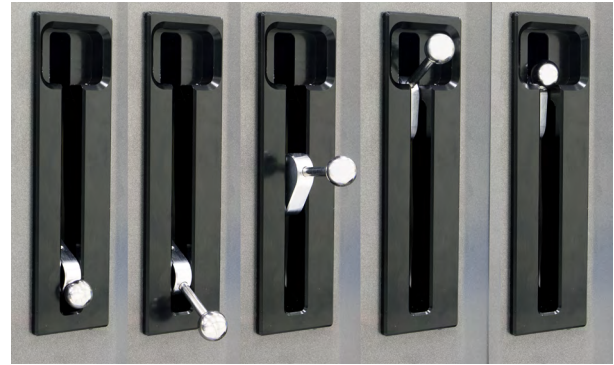

Minimized CDA Consumption

With the ERS patented technology, using the chiller for purging the IceFreeEnvironment™, the CDA consumption is reduced by as much as 50%. Nitrogen purging is also possible by using separate, automated valve. This “refurbished” CDA is used in addition for probe platen and probe card cooling.

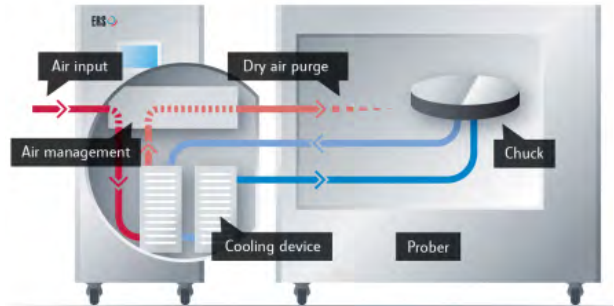

* Picture is courteously provided by ERS.

SENTIO® - Probe Station Control Software

MPI automated engineering probe systems are controlled by a unique and revolutionary, multi-touch operation SENTIO® Software Suite – simple and intuitive operation saves significant training time, the Scroll, Zoom, and Move commands mimic modern smart mobile devices and allows everyone to become an expert in just minutes. Switching between the active application and the rest of the APPs is just a matter of a simple finger sweep.

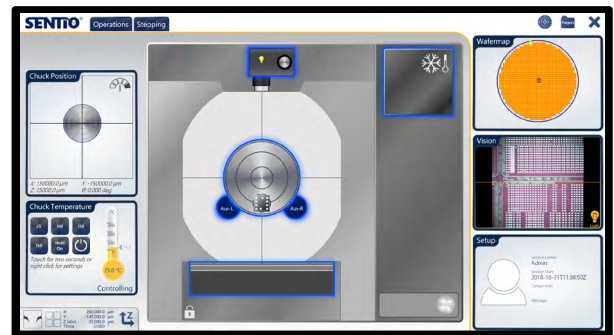

QAlibria® - RF Calibration Software

By implementing intuitive multi-touch operation, QAlibria® provides crisp and clear guidance to the RF calibration process, minimizes configuration mistakes and helps to reach accurate calibration results in fastest time. QAlibria® offers industry standard and advanced calibration methods. QAlibria® includes TOSM (SOLT), TMR, TMRR methods, and 4-port calibration capability additionally to the integration of NIST StatistiCal calibration packages providing easy access to the NIST multiline TRL metrology-level calibration and uncertain analysis.

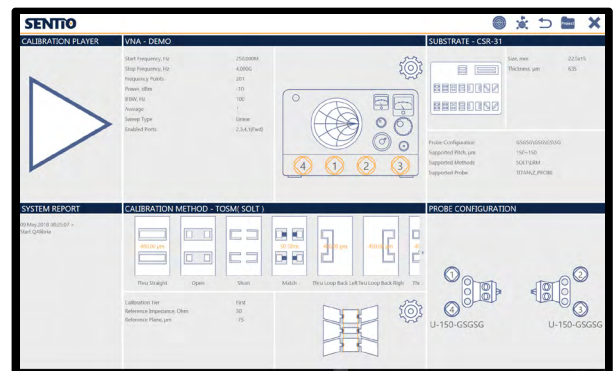

OPTIONAL FEATURES

DarkBox

DarkBox allows light sensitive measurement capability and in case of TS2000-IFE interlock system for safety measurements up to 10kV and 600A. See all dimensions on the last page.



Vertical Control Environment™ (VCE™)

The VCE™ allows the probing area to be observed from the side for safe operation. It automatically detects the height of the tips and defines the position of the chuck contact. The wizard-guided setup procedure takes into account working with probe cards and DC or RF probes. It saves time during initial contacting and prevents damage to probes or pads, especially in the covered MPI ShieldEnvironment™.

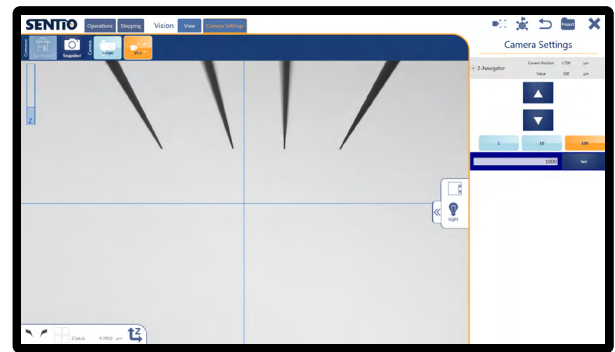

mDrive™

In addition to the standard joystick control, mDrive™ provides a truly intuitive, manual, one or two hands operation of all existing programmable stages, such as chuck, scope or MicroPositioners. X- and Y-axis fine control is available for the selected stage, where Z safety function requires additional enabling.



THZ-Selection

It converts TS2000-IFE system into a dedicated, mmW and THz probe station, as the first one on the market:

- Automated testing of 200 mm wafers with unsurpassed measurement accuracy is possible now
- The MPI THZ-Selection incorporates MPI's innovative design of frequency extender's integration, developed for TS200-THZ, which hovers the extender over the entire 300 mm wafer
- This minimizes the distance to the DUT to a minimum in order to provide best possible measurement directivity and accuracy

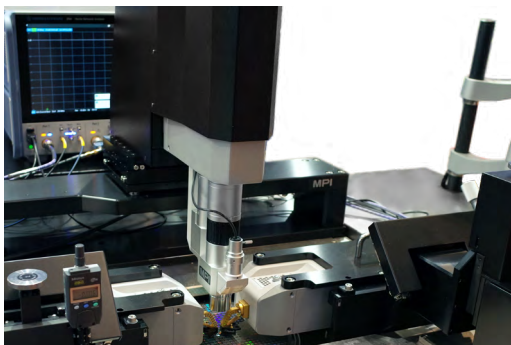

ShieldCap™

The ShieldCap™ option converts the TS2000-IFE into a ShieldEnvironment™ system. The MPI ShieldEnvironment™ is a high performance local environmental chamber providing excellent EMI- and light- tight shielded test environment for ultra-low noise, low capacitance measurements. MPI ShieldEnvironment™ allows up to 4-port RF or up to 8-ports DC/Kelvin or a combination of those configurations. MPI ShieldCap™ provides easy reconfiguration of measurement setup as well as EMI/noise shielding - which make great difference in simplifying day to day operations.

ShieldEnvironment™ Electrical Specifications*

EMI shielding	> 30 dB (typical) @ 1 kHz to 1 MHz
Light attenuation	≥ 130 dB
Spectral noise floor	≤ -180 dBVrms/rtHz (≤ 1 MHz)
System AC noise	≤ 5 mVp-p (≤ 1 GHz)

*Including 4 MicroPositioners.

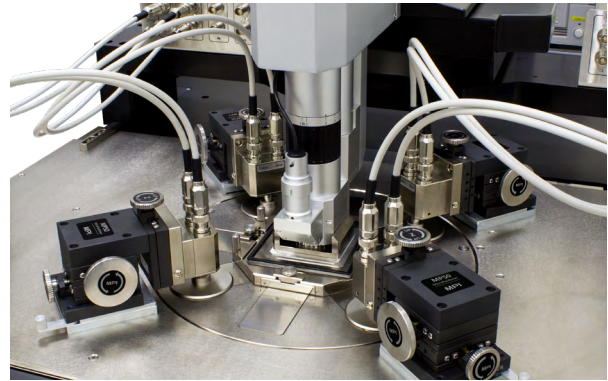
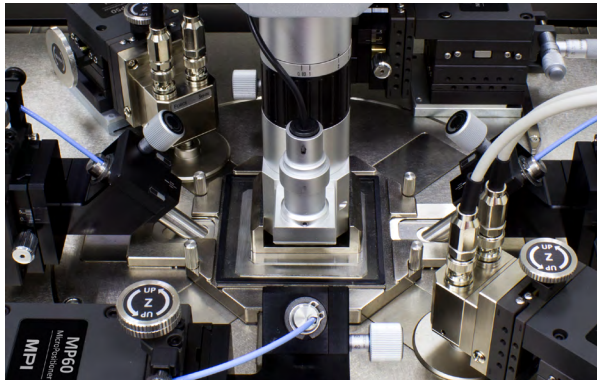

Automated Wafer Loading: WaferWallet®MAX



Number of cassettes	1
Cassette type	Semi Standard, opened
Supported wafer sizes	100, 150 or 200 mm
Pre-aligner and cassette scanner	Included
Wafer ID-Reader	Option for top or bottom ID reading Revolutionary integrated RGB illumination Fully automatic exposure control Code shift compensation OCR, Barcode, DataMatrix and QR code
Signal light tower	Four color, LED steady / flashing tower lights

NON-THERMAL CHUCKS

Standard Wafer Chuck

Connectivity	Coax BNC (f)
Diameter	210 mm
Material	Stainless steel
Chuck surface	Planar with centric engraved vacuum grooves
Vacuum grooves sections (diameter)	3, 27, 45, 69, 93, 117, 141, 164, 194 mm
Vacuum actuation	Multizone control - All connected in meander shape, center hole in 3 mm diameter
Supported DUT sizes	Single DUTs down to 5x5 mm size or wafers 50 mm (2 in) thru 200 mm (8 in)*
Surface planarity	$\leq \pm 5 \mu\text{m}^{**}$
Rigidity	$< 15 \mu\text{m} / 10 \text{ N @edge}$

*Single DUT testing requires higher vacuum conditions dependent upon testing application.

**By using SENTIO® topography

RF Wafer Chuck

Connectivity	Kelvin Triax (f)
Diameter	210 mm with 2 integrated AUX areas
Material	Nickel plated aluminum (flat with 0.5 mm holes)
Chuck surface	Planar with 0.5 mm diameter holes in centric sections
Vacuum holes sections (diameter)	3, 27, 45, 69, 93, 117, 141, 164, 194 mm
SmartVacuum™ distribution	In center for 5x5 mm (4 holes), 100, 150, 200 mm wafer (4, 6, 8 in)
Supported DUT sizes	Single DUTs down to 5x5 mm size or wafers 100 mm (4 in) thru 200 mm (8 in)*
Surface planarity	$\leq \pm 5 \mu\text{m}^{**}$
Rigidity	$< 15 \mu\text{m} / 10 \text{ N @edge}$

*Single DUT testing requires higher vacuum conditions dependent upon testing application.

**By using SENTIO® topography

Auxiliary Chuck

Quantity	2 AUX chucks
Position	Integrated to front side of main chuck
Substrate size (W x L)	Max. 25 x 25 mm (1 x 1 in)
Material	Ceramic, RF absorbing material for accurate calibration
Surface planarity	$\leq \pm 5 \mu\text{m}$
Vacuum control	Controlled independently, separate from chucks

Electrical Specification (Coax)

Operation voltage	In accordance with EC 61010, certificates for higher voltages available upon request
Maximum voltage between chuck top and GND	500 V DC
Isolation	$> 2 \text{ G}\Omega$

Electrical Specification (Triax)

Chuck isolation	Standard Chuck (10 V)
Force to guard	$\geq 1 \text{ T}\Omega$
Guard to shield	$\geq 1 \text{ T}\Omega$
Force to shield	$\geq 5 \text{ T}\Omega$

THERMAL CHUCKS

Specifications of MPI ERS AirCool® Technology

	Ambient to 150/200 °C	20 °C to 150/200 °C	-40 °C to 150/200 °C
Connectivity	Coax BNC (f)	Coax BNC (f)	Coax BNC (f)
Temperature control method	Cooling air / Resistance heater	Cooling air / Resistance heater	Cooling air / Resistance heater
Coolant	Air (user supplied)	Air (user supplied)	Air (user supplied)
Smallest temperature selection step	0.1 °C	0.1 °C	0.1 °C
Chuck temperature display resolution	0.1 °C	0.1 °C	0.1 °C
External touchscreen display operation	N/A	N/A	N/A
Temperature stability	±0.5 °C	±0.5 °C	±0.5 °C
Temperature accuracy	±1 °C	±1 °C	±1 °C
Control method	DC/PID	DC/PID	DC/PID
Chuck pinhole surface plating: 200 °C	Nickel	Nickel	Nickel
SmartVacuum™ distribution	In center for 5x5 mm (4 holes) 100, 150, 200 mm (4, 6, 8 in)		
Temperature sensor	Pt100 1/3DIN	Pt100 1/3DIN	Pt100 1/3DIN
Temperature uniformity	< ±1 °C	< ±1 °C	< ±1 °C
Surface flatness and base parallelism	< ±15 µm	< ±15 µm	< ±15 µm
Max. Voltage between			
Force-to-GND	500 V DC	500 V DC	500 V DC
Heating rates*	35 to 150 °C < 12 min 35 to 200 °C < 18 min	20 to 150 °C < 12 min 20 to 200 °C < 23 min	-40 to 25 °C < 12 min 25 to 200 °C < 16 min
Cooling rates*	150 to 35 °C < 15 min 200 to 35 °C < 18 min	150 to 20 °C < 18 min 200 to 20 °C < 30 min	200 to 25 °C < 20 min 25 to -40 °C < 36 min
Leakage @ 10 V	N/A	N/A	N/A
Electrical isolation	> 0.5 T Ω at 25 °C	> 0.5 T Ω at 25 °C	> 0.5 T Ω at 25 °C
Capacitance	< 750 pF	< 750 pF	< 750 pF

*Typical data for all chucks based on FPS requirements.

Specifications of MPI ERS AirCool® PRIME Technology

	Ambient to 200/300 °C	20 °C to 200/300 °C	Ambient to 200/300 °C	20 °C to 200/300 °C
Chuck type	RF	RF	Ultra low noise	Ultra low noise
Connectivity	Kelvin Triax (f)	Kelvin Triax (f)	Kelvin Triax (f)	Kelvin Triax (f)
Temperature control method	Cooling air / Resistance heater	Cooling air / Resistance heater	Cooling air / Resistance heater	Cooling air / Resistance heater
Coolant	Air (user supplied)	Air (user supplied)	Air (user supplied)	Air (user supplied)
Smallest temperature selection step	0.1 °C	0.1 °C	0.1 °C	0.1 °C
Chuck temperature display resolution	0.01 °C	0.01 °C	0.01 °C	0.01 °C
External touchscreen display operation	Yes	Yes	Yes	Yes
Temperature stability	±0.08 °C	±0.08 °C	±0.08 °C	±0.08 °C
Temperature accuracy	±0.1 °C	0.1 °C	0.1 °C	0.1 °C
Control method	Low noise DC/PID	Low noise DC/PID	Low noise DC/PID	Low noise DC/PID
Chuck pinhole surface plating: 200°C / 300°C	Nickel / Gold	Nickel / Gold	Nickel / Gold	Nickel / Gold
SmartVacuum™ distribution	In front for single DUT 5x5 mm (4 holes) and 50 mm (2 in) In center for 100, 150, 200 mm wafer (4, 6, 8 in)			
Temperature sensor	Pt100 1/3DIN, 4-line wired	Pt100 1/3DIN, 4-line wired	Pt100 1/3DIN, 4-line wired	Pt100 1/3DIN, 4-line wired
Temperature uniformity	< ±0.5 °C at ≤ 200 °C < ±1 °C at > 200 °C	< ±0.5 °C at ≤ 200 °C < ±1 °C at > 200 °C	< ±0.5 °C at ≤ 200 °C < ±1 °C at > 200 °C	< ±0.5 °C at ≤ 200 °C < ±1 °C at > 200 °C
Surface flatness and base parallelism	< ±12 μm	< ±12 μm	< ±12 μm	< ±12 μm
Max. Voltage between				
Force-to-GND	600 V DC	600 V DC	600 V DC	600 V DC
Force-to-Guard	100 V DC	100 V DC	600 V DC	600 V DC
Guard-to-GND	400 V DC	400 V DC	400 V DC	400 V DC
Heating rates*	35 to 200 °C < 16 min 35 to 300 °C < 20 min	20 to 200 °C < 15 min 20 to 300 °C < 22 min	35 to 200 °C < 18 min 35 to 300 °C < 26 min	20 to 200 °C < 16 min 20 to 300 °C < 28 min
Cooling rates*	200 to 35 °C < 27 min 300 to 35 °C < 33 min	200 to 20 °C < 33 min 300 to 20 °C < 40 min	200 to 35 °C < 27 min 300 to 35 °C < 34 min	200 to 20 °C < 41 min 300 to 20 °C < 42 min
Leakage @ 10 V	N/A	N/A	< 15 fA at 25 °C < 30 fA at 200 °C < 50 fA at 300 °C	< 15 fA at 25 °C < 30 fA at 200 °C < 50 fA at 300 °C
Electrical isolation	> 5 T Ω at 25 °C > 1 T Ω at 200 °C > 0.5 T Ω at 300 °C	> 5 T Ω at 25 °C > 1 T Ω at 200 °C > 0.5 T Ω at 300 °C	N/A	N/A
Capacitance				
Force-to-Guard	< 1600 pF	< 1600 pF	< 600 pF	< 600 pF
Guard-to-Shield	< 2000 pF	< 2000 pF	< 2000 pF	< 2000 pF

*Typical data for all chucks based on FPS requirements.

Specifications of MPI ERS AirCool® PRIME with Fusion Chiller Technology

	-10 °C to 200/300 °C	-40 °C to 200/300 °C	-60 °C to 200/300 °C
Chuck type	RF	RF	RF
Connectivity	Kelvin Triax (f)	Kelvin Triax (f)	Kelvin Triax (f)
Temperature control method	Cooling air / Resistance heater	Cooling air / Resistance heater	Cooling air / Resistance heater
Coolant	Air (user supplied)	Air (user supplied)	Air (user supplied)
Smallest temperature selection step	0.1 °C	0.1 °C	0.1 °C
Chuck temperature display resolution	0.01 °C	0.01 °C	0.01 °C
External touchscreen display operation	Yes	Yes	Yes
Temperature stability	±0.08 °C	±0.08 °C	±0.08 °C
Temperature accuracy	0.1 °C	0.1 °C	0.1 °C
Control method	Low noise DC/PID	Low noise DC/PID	Low noise DC/PID
Interfaces	RS232C	RS232C	RS232C
Chuck pinhole surface plating: 200°C / 300°C	Nickel / Gold	Nickel / Gold	Nickel / Gold
SmartVacuum™ distribution	In front for single DUT 5x5 mm (4 holes) and 50 mm (2 in) In center for 100, 150, 200 mm wafer (4, 6, 8 in)		
Temperature sensor	Pt100 1/3DIN, 4-line wired	Pt100 1/3DIN, 4-line wired	Pt100 1/3DIN, 4-line wired
Temperature uniformity	< ±0.5 °C at ≤ 200 °C < ±1 °C at > 200 °C	< ±0.5 °C at ≤ 200 °C < ±1 °C at > 200 °C	< ±0.5 °C at ≤ 200 °C < ±1 °C at > 200 °C
Surface flatness and base parallelism	< ±12 μm	< ±12 μm	< ±12 μm
Max. Voltage between			
Force-to-GND	600 V DC	600 V DC	600 V DC
Force-to-Guard	100 V DC	100 V DC	100 V DC
Guard-to-GND	400 V DC	400 V DC	400 V DC
Heating rates*			
25 °C	-10 to 25 °C < 2 min	-40 to 25 °C < 4 min	-60 to 25 °C < 5 min
200 °C	25 to 200 °C < 13 min		25 to 200 °C < 12 min
300 °C	25 to 300 °C < 22 min		25 to 300 °C < 22 min
Cooling rates*			
AC3 Mode	300 °C	300 to 25 °C < 10 min	300 to 25 °C < 14 min
	200 °C	200 to 25 °C < 9 min	200 to 25 °C < 11 min
	25 °C	25 to -10 °C < 6 min	25 to -40 °C < 12 min
TURBO Mode	300 °C	300 to 25 °C < 10 min	300 to 25 °C < 12 min
	200 °C	200 to 25 °C < 9 min	200 to 25 °C < 9 min
	25 °C	25 to -10 °C < 6 min	25 to -40 °C < 9 min
Leakage @ 10 V	N/A	N/A	N/A
Electrical isolation	> 5 T Ω at 25 °C or below > 1 T Ω at 200 °C, > 0.5 T Ω at 300 °C		
Capacitance			
Force-to-Guard	< 1600 pF	< 1600 pF	< 1600 pF
Guard-to-Shield	< 2000 pF	< 2000 pF	< 2000 pF

*Typical data for all chucks based on FPS requirements.

Specifications of MPI ERS AirCool® PRIME with Fusion Chiller Technology

	-10 °C to 200/300 °C	-40 °C to 200/300 °C	-60 °C to 200/300 °C
Chuck type	Ultra low noise	Ultra low noise	Ultra low noise
Connectivity	Kelvin Triax (f)	Kelvin Triax (f)	Kelvin Triax (f)
Temperature control method	Cooling air / Resistance heater	Cooling air / Resistance heater	Cooling air / Resistance heater
Coolant	Air (user supplied)	Air (user supplied)	Air (user supplied)
Smallest temperature selection step	0.1 °C	0.1 °C	0.1 °C
Chuck temperature display resolution	0.01 °C	0.01 °C	0.01 °C
External touchscreen display operation	Yes	Yes	Yes
Temperature stability	±0.08 °C	±0.08 °C	±0.08 °C
Temperature accuracy	0.1 °C	0.1 °C	0.1 °C
Control method	Low noise DC/PID	Low noise DC/PID	Low noise DC/PID
Interfaces	RS232C	RS232C	RS232C
Chuck pinhole surface plating: 200°C / 300°C	Nickel / Gold	Nickel / Gold	Nickel / Gold
SmartVacuum™ distribution	In front for single DUT 5x5 mm (4 holes) and 50 mm (2 in) In center for 100, 150, 200 mm wafer (4, 6, 8 in)		
Temperature sensor	Pt100 1/3DIN, 4-line wired	Pt100 1/3DIN, 4-line wired	Pt100 1/3DIN, 4-line wired
Temperature uniformity	< ±0.5 °C at ≤ 200 °C < ±1 °C at > 200 °C	< ±0.5 °C at ≤ 200 °C < ±1 °C at > 200 °C	< ±0.5 °C at ≤ 200 °C < ±1 °C at > 200 °C
Surface flatness and base parallelism	< ±12 μm	< ±12 μm	< ±12 μm
Max. Voltage between			
Force-to-GND	600 V DC	600 V DC	600 V DC
Force-to-Guard	600 V DC	600 V DC	600 V DC
Guard-to-GND	400 V DC	400 V DC	400 V DC
Heating rates*			
25 °C	-10 to 25 °C < 3 min	-40 to 25 °C < 4 min	-60 to 25 °C < 5 min
200 °C		25 to 200 °C < 15 min	
300 °C		25 to 300 °C < 26 min	
Cooling rates*			
AC3 Mode	300 °C	300 to 25 °C < 14 min	300 to 25 °C < 16 min
	200 °C	200 to 25 °C < 11 min	200 to 25 °C < 13 min
	25 °C	25 to -10 °C < 8 min	25 to -40 °C < 15 min
TURBO Mode	300 °C	300 to 25 °C < 14 min	300 to 25 °C < 14 min
	200 °C	200 to 25 °C < 11 min	200 to 25 °C < 11 min
	25 °C	25 to -10 °C < 8 min	25 to -40 °C < 13 min
Leakage @ 10 V			
-10, -40 or -60 °C	< 30 fA	< 30 fA	< 30 fA
25 °C	< 15 fA	< 15 fA	< 15 fA
200 °C	< 30 fA	< 30 fA	< 30 fA
300 °C	< 50 fA	< 50 fA	< 50 fA

Capacitance

Force-to-Guard	< 600 pF	< 600 pF	< 600 pF
Guard-to-Shield	< 2000 pF	< 2000 pF	< 2000 pF

*Typical data for all chucks based on FPS requirements.

THERMAL CHUCKS DIMENSIONS

System Controller / Chiller Dimensions and Power / Air Consumption

System type	W x D x H (mm)	Weight (kg)	Power cons. (VA)	max. Air flow* (l/min)	CDA dew Point
Ambient	300 x 360 x 135	12	1200	400	≤ 0 °C
20°C, -10 °C to 200 / 300 °C	300 x 360 x 135	12	1200	400	≤ -30 °C
-40 to 200 / 300 °C	420 x 300 x 520	45	1200	400	≤ -40 °C
-60 to 200 / 300 °C	420 x 500 x 1020	140	2400	450	≤ -40 °C
Electrical primary connection	100 to 240 VAC auto switch				
Electrical frequency	50 Hz / 60 Hz				
Compressed air supply	6.0 bar (0.8 MPa, 87 psi)				



ERS AirCool® Fusion*, Controller Integrated Chiller -40 °C / -60 °C



ERS AirCool® Fusion*, Controller Integrated Chiller -10 °C

*ERS electronic GmbH patented solution

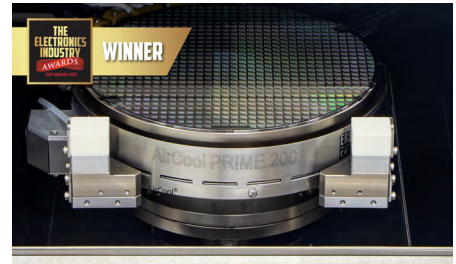

ERS and MPI's joint product AirCool® PRIME Chuck won "Electronics Industry Awards 2018" in the category, "Test, Measurement and Inspection Product of the year".

TYPICAL TRANSITION TIME

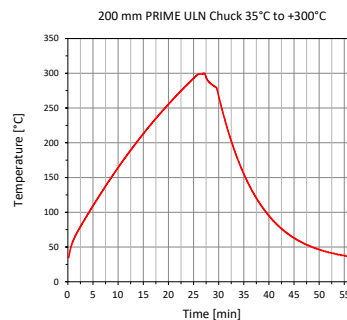
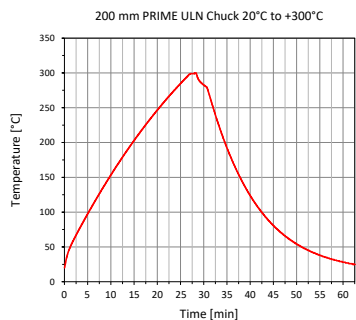
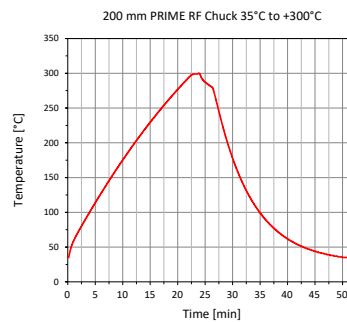
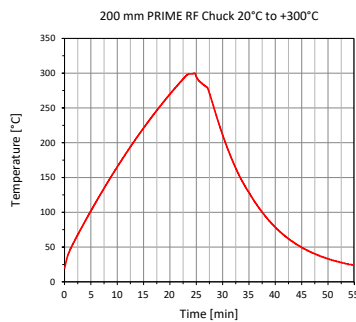

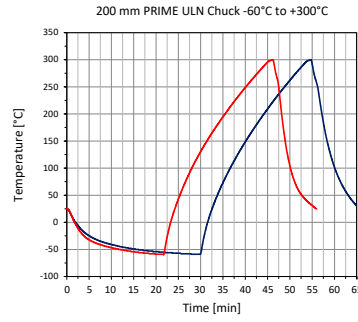
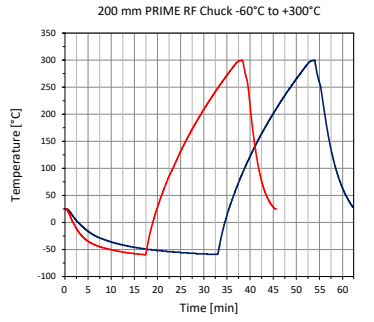
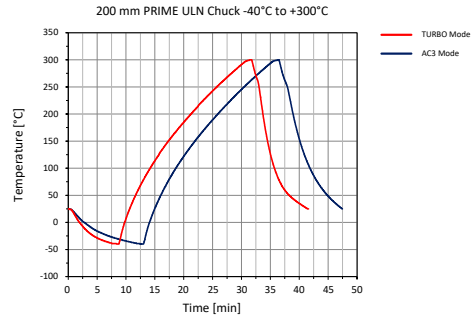
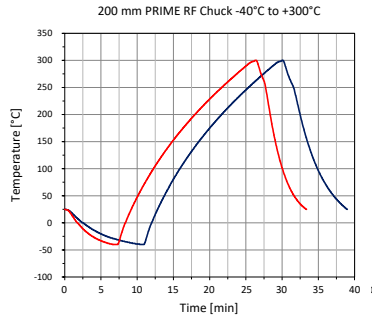
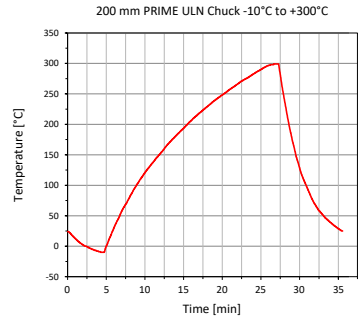
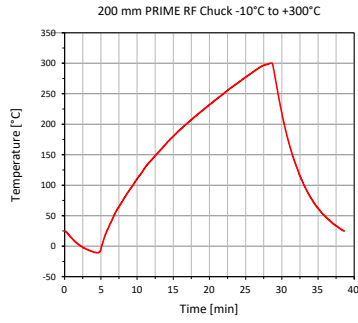

SYSTEM CONTROLLER SPECIFICATIONS

CPU	Intel Core i7
RAM	16 GB
64 bit operating system	Windows 10 Professional (English) 64 bit
Storage	500 GB SSD
LAN	1 x internal, 1 x external TCP/IP port
USB Ports	3 x internal, 1 x external
GPIB interface	Optional

SUPPORTED SOFTWARE PLATFORMS

Drivers	WaferPro / IC-CAP & EasyEXPERT from Keysight, BSIMPro & NoisePro from ProPlus, ACS from Keithley
Emulation mode	Available for various prober control software*

*Please contact your local support for more details.

FACILITY REQUIREMENTS

General Probe System

Power	100-240 VAC nominal ; 50/60 Hz
Vacuum	-0.9 bar
Compressed air	6.0 bar
Audible Noise	≤ 55 dB(A) (sound pressure level at 1 m distance)

REGULATORY COMPLIANCE

3rd party, TÜV tested according to

- IEC 61010-1: 2010 + Am1:2016; EN 61010-1: 2010; IEC/EN 61010-2-010: 2014; IEC/EN 61010-2-081: 2015; EN ISO 12100: 2010; UL 61010-1: 2012/R: 2016-04; UL 61010-2-010: 2015; CAN/CSA-C22.2 No. 61010-1: 2012/U2: 2016-04; CAN/CSA-C22.2 No. 61010-2-010:2015

and certified for CE and US/Canada (NRTL), SEMI S2 and S8.

Copies of certificates are available on request

WARRANTY

- Warranty*: 12 months
- Extended service contract: contact MPI Corporation for more information

*See MPI Corporation's Terms and Conditions of Sale for more details.

PHYSICAL DIMENSIONS

TS2000-IFE

System dimensions (W x D x H)	1210 x 1190 x 1570 mm (47.6 x 46.9 x 61.8 in)
Weight	800 kg (includes system, accessories, and chiller)

*Can increase depends on operator manual adjustment or interaction.

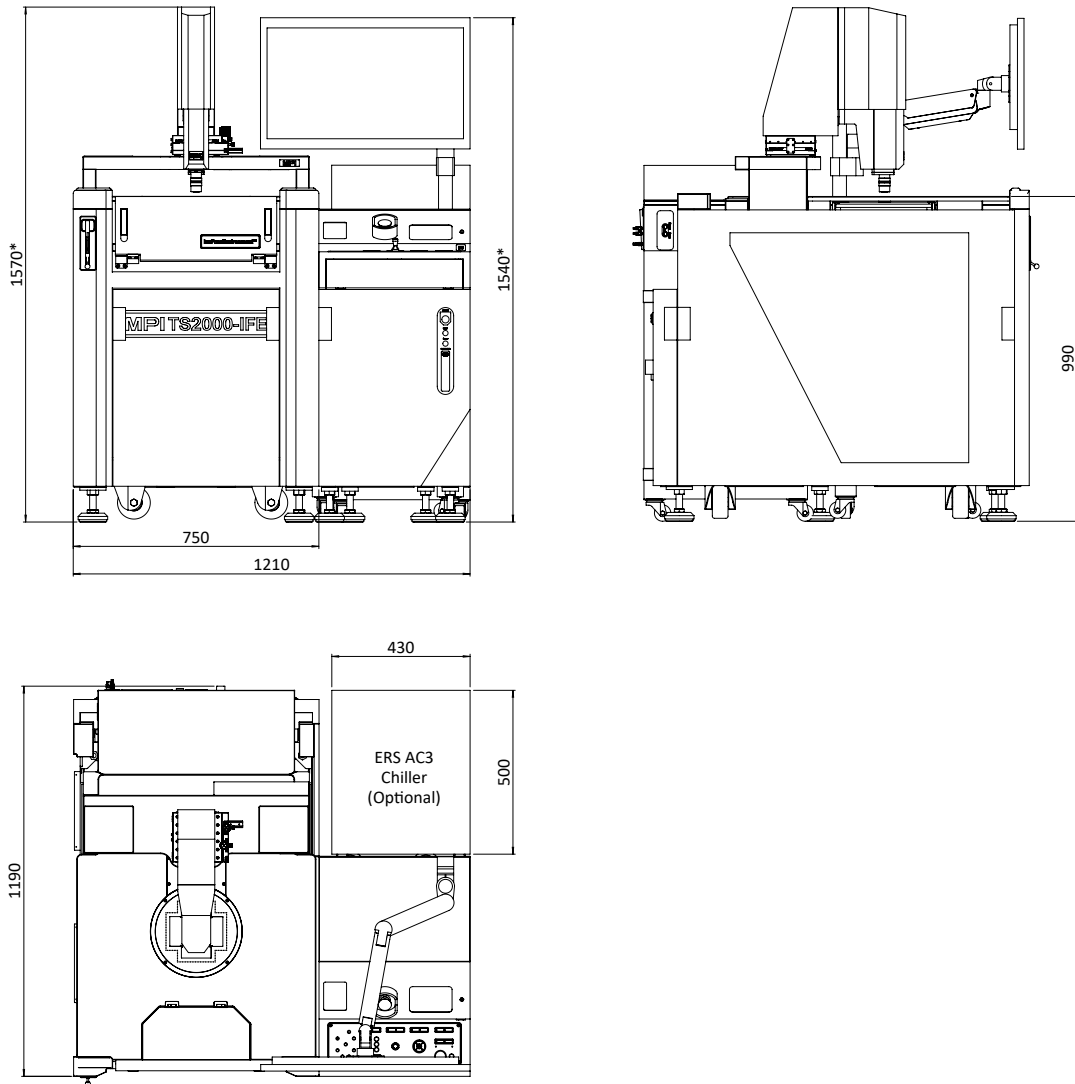

WaferWallet®MAX

System dimensions (W x D x H)	500 x 1160 x 970 mm (19.7 x 45.7 x 38.2 in)
Weight	200 kg

*Can increase depends on operator manual adjustment or interaction.

TS2000-IFE with WaferWallet®MAX

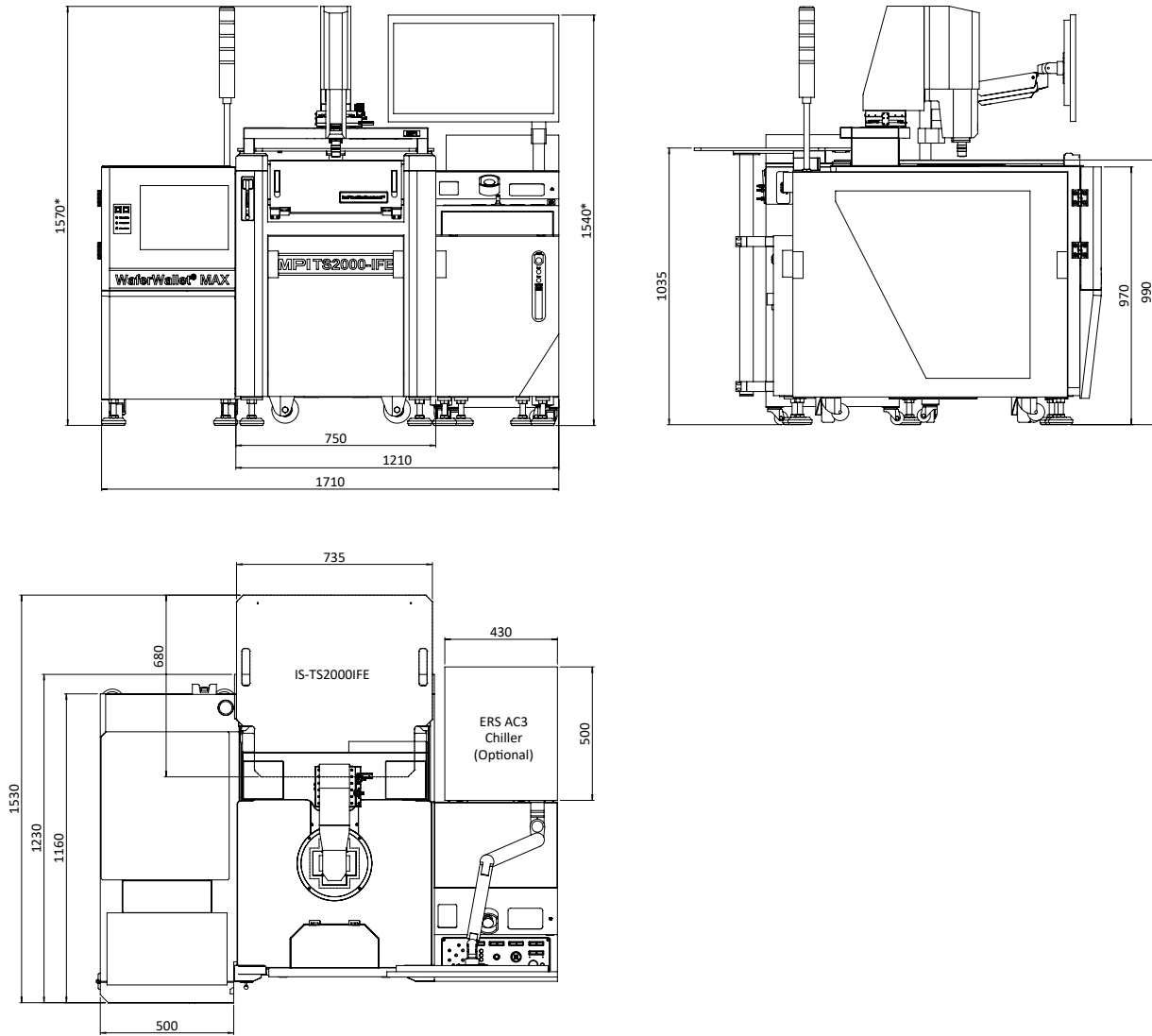

TS2000-IFE with DarkBox

System dimensions (W x D x H)	1250 x 1350 x 1720 mm (49.2 x 53.1 x 67.7 in)
Weight	895 kg

**Can increase depends on operator manual adjustment or interaction.*

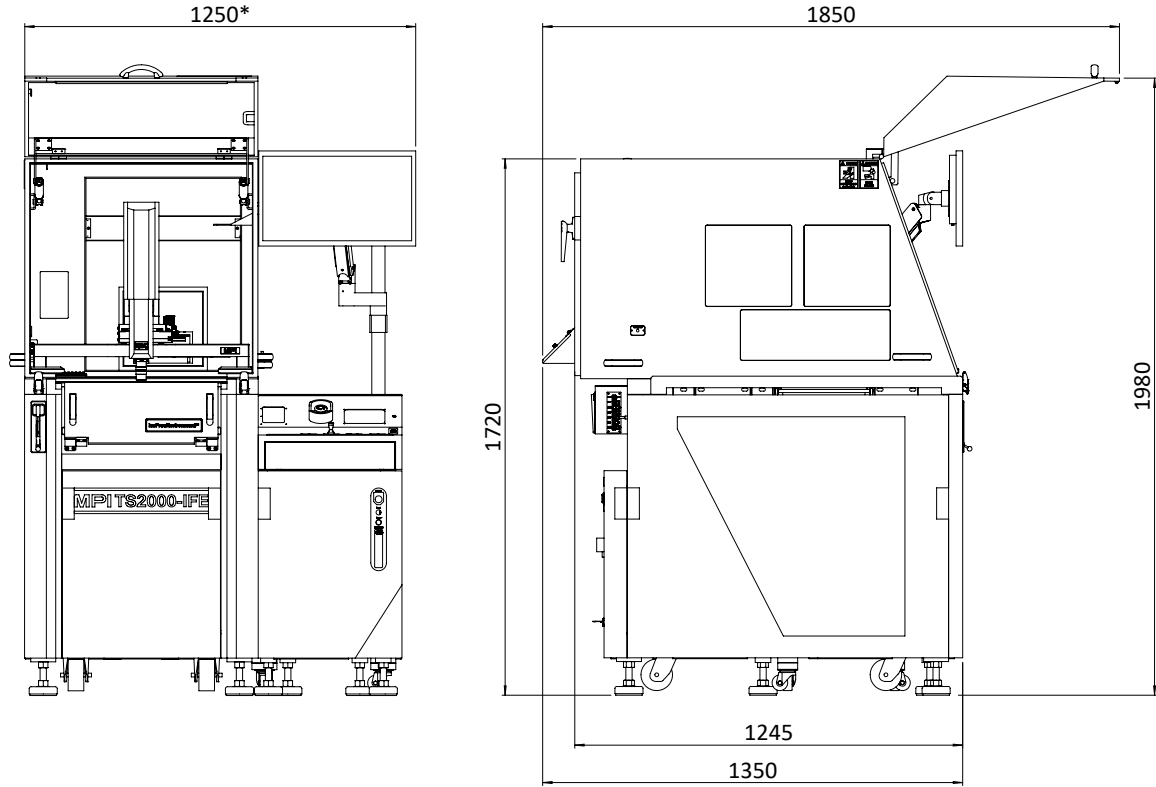

Direct contact:
 Asia region: ast-asia@mpi-corporation.com
 EMEA region: ast-europe@mpi-corporation.com
 America region: ast-americas@mpi-corporation.com

MPI global presence: for your local support, please find the right contact here:
www.mpi-corporation.com/ast/support/local-support-worldwide

© 2024 Copyright MPI Corporation. All rights reserved.

MPI Global Presence

